

# EYP-DFB-0767-00050-1500-BFW01-0005

Revision 0.93

2020-11-11

## SINGLE FREQUENCY LASER DIODES

### Distributed Feedback Laser

#### General Product Information

| Product                                                       | Application              |
|---------------------------------------------------------------|--------------------------|
| 767 nm DFB Laser                                              | Spectroscopy (K D2 line) |
| with hermetic 14-Pin Butterfly Housing (ROHS compliant)       | Metrology                |
| including Monitor Diode, Thermoelectric Cooler and Thermistor |                          |
| with integrated Beam Collimation                              |                          |

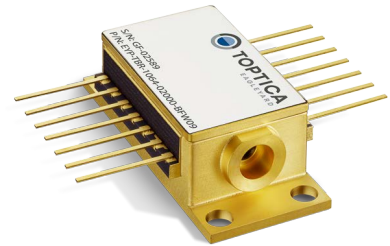

#### Absolute Maximum Ratings

| Parameter                             | Symbol    | Unit | min | typ | max |
|---------------------------------------|-----------|------|-----|-----|-----|
| Storage Temperature                   | $T_S$     | °C   | -40 |     | 85  |
| Operational Temperature at Case       | $T_C$     | °C   | -40 |     | 85  |
| Operational Temperature at Laser Chip | $T_{LD}$  | °C   | 10  |     | 50  |
| Forward Current                       | $I_F$     | mA   |     |     | 140 |
| Reverse Voltage                       | $V_R$     | V    |     |     | 2   |
| Output Power                          | $P_{opt}$ | mW   |     |     | 60  |
| TEC Current                           | $I_{TEC}$ | A    |     |     | 1.8 |
| TEC Voltage                           | $V_{TEC}$ | V    |     |     | 2.8 |

#### Measurement Conditions / Comments

Stress in excess of one of the Absolute Maximum Ratings may damage the laser. Please note that a damaging optical power level may occur although the maximum current is not reached. These are stress ratings only, and functional operation at these or any other conditions beyond those indicated under Recommended Operational Conditions is not implied.

#### Recommended Operational Conditions

| Parameter                             | Symbol     | Unit | min | typ | max |
|---------------------------------------|------------|------|-----|-----|-----|
| Operational Temperature at Case       | $T_{case}$ | °C   | -20 |     | 65  |
| Operational Temperature at Laser Chip | $T_{LD}$   | °C   | 15  |     | 35  |
| Forward Current                       | $I_F$      | mA   |     |     | 130 |
| Output Power                          | $P_{opt}$  | mW   | 10  |     | 50  |

#### Measurement Conditions / Comments

measured by integrated Thermistor

#### Characteristics at $T_{LD} = 25^\circ$ at BOL

| Parameter                  | Symbol                 | Unit | min | typ   | max |
|----------------------------|------------------------|------|-----|-------|-----|
| Center Wavelength          | $\lambda_C$            | nm   | 766 | 767   | 768 |
| Target Wavelength          | $\lambda_T$            | nm   |     | 766.7 |     |
| Linewidth (FWHM)           | $\Delta\lambda$        | MHz  |     | 0.6   | 1   |
| Mode-hop free Tuning Range | $\Delta\lambda_{tune}$ | pm   | 20  |       |     |
| Sidemode Suppression Ratio | SMSR                   | dB   | 30  | 50    |     |

#### Measurement Conditions / Comments

see images on page 4

reached within  $T_{LD} = 15^\circ \dots 35^\circ\text{C}$  at 50 mW

$P_{opt} = 50$  mW

reached by current modulation

$P_{opt} = 50$  mW

# EYP-DFB-0767-00050-1500-BFW01-0005

Revision 0.93

2020-11-11

## SINGLE FREQUENCY LASER DIODES Distributed Feedback Laser

### Characteristics at $T_{LD} = 25^\circ$ at BOL cont'd

| Parameter                             | Symbol           | Unit     | min | typ   | max |
|---------------------------------------|------------------|----------|-----|-------|-----|
| Temperature Coefficient of Wavelength | $d\lambda / dT$  | nm / K   |     | 0.06  |     |
| Current Coefficient of Wavelength     | $d\lambda / dI$  | nm / mA  |     | 0.003 |     |
| Laser Current @ $P_{opt} = 50$ mW     | $I_{LD}$         | mA       |     |       | 130 |
| Slope Efficiency                      | $\eta$           | W / A    |     | 0.9   |     |
| Threshold Current                     | $I_{th}$         | mA       |     |       | 70  |
| Divergence parallel (FWHM)            | $\Theta_{  }$    | $^\circ$ |     | 0.1   |     |
| Divergence perpendicular (FWHM)       | $\Theta_{\perp}$ | $^\circ$ |     | 0.1   |     |
| Beam Diameter horizontal              | $d_{  }$         | mm       |     | 1.0   | 1.2 |
| Beam Diameter vertical                | $d_{\perp}$      | mm       |     | 0.8   | 1.2 |
| Degree of Polarization                | DOP              | %        |     | 60    |     |

### Measurement Conditions / Comments

parallel to the base plate of the housing (see p. 3)  
perpendicular to base plate of the housing (see p. 3)  
parallel to the base plate of the housing (see p. 3)  
perpendicular to base plate of the housing (see p. 3)  
 $P_{opt} = 50$  mW; E field perpendicular to the base plate

### Monitor Diode

| Parameter                     | Symbol              | Unit       | min | typ | max |
|-------------------------------|---------------------|------------|-----|-----|-----|
| Monitor Detector Responsivity | $I_{mon} / P_{opt}$ | $\mu A/mW$ | 0.5 |     | 40  |

### Measurement Conditions / Comments

$U_R = 5$  V

### Thermoelectric Cooler

| Parameter                              | Symbol     | Unit | min | typ | max |
|----------------------------------------|------------|------|-----|-----|-----|
| Current                                | $I_{TEC}$  | A    |     | 0.4 |     |
| Voltage                                | $U_{TEC}$  | V    |     | 0.8 |     |
| Power Dissipation (total loss at case) | $P_{loss}$ | W    |     | 0.4 |     |
| Temperature Difference                 | $\Delta T$ | K    |     |     | 50  |

### Measurement Conditions / Comments

$P_{opt} = 50$  mW,  $\Delta T = 20$  K  
 $P_{opt} = 50$  mW,  $\Delta T = 20$  K  
 $P_{opt} = 50$  mW,  $\Delta T = 20$  K  
 $P_{opt} = 50$  mW,  $\Delta T = |T_{case} - T_{LD}|$

### Thermistor (Standard NTC Type)

| Parameter                      | Symbol  | Unit       | min | typ                      | max |
|--------------------------------|---------|------------|-----|--------------------------|-----|
| Resistance                     | R       | k $\Omega$ |     | 10                       |     |
| Beta Coefficient               | $\beta$ |            |     | 3892                     |     |
| Steinhart & Hart Coefficient A | A       |            |     | $1.1293 \times 10^{#NV}$ |     |
| Steinhart & Hart Coefficient B | B       |            |     | $2.3410 \times 10^{#NV}$ |     |
| Steinhart & Hart Coefficient C | C       |            |     | $8.7755 \times 10^{#NV}$ |     |

### Measurement Conditions / Comments

$T_{LD} = 25^\circ$  C  
 $R_1 / R_2 = e^{\beta(1/T_1 - 1/T_2)}$  at  $T_{LD} = 0^\circ \dots 50^\circ$  C  
 $1/T = A + B(\ln R) + C(\ln R)^3$   
T: temperature in Kelvin  
R: resistance at T in Ohm

# EYP-DFB-0767-00050-1500-BFW01-0005

Revision 0.93

2020-11-11

## SINGLE FREQUENCY LASER DIODES Distributed Feedback Laser

### Pin Assignment

|   |                           |    |                           |
|---|---------------------------|----|---------------------------|
| 1 | Thermoelectric Cooler (+) | 14 | Thermoelectric Cooler (-) |
| 2 | Thermistor                | 13 | Case                      |
| 3 | Photodiode (Anode)        | 12 | not connected             |
| 4 | Photodiode (Cathode)      | 11 | Laser Diode (Cathode)     |
| 5 | Thermistor                | 10 | Laser Diode (Anode)       |
| 6 | not connected             | 9  | not connected             |
| 7 | not connected             | 8  | not connected             |

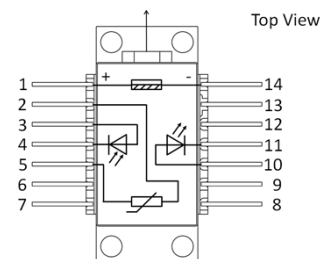

### Package Drawings

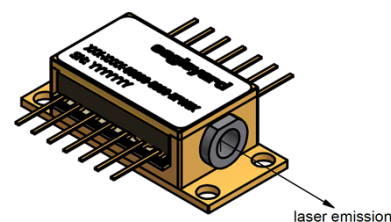
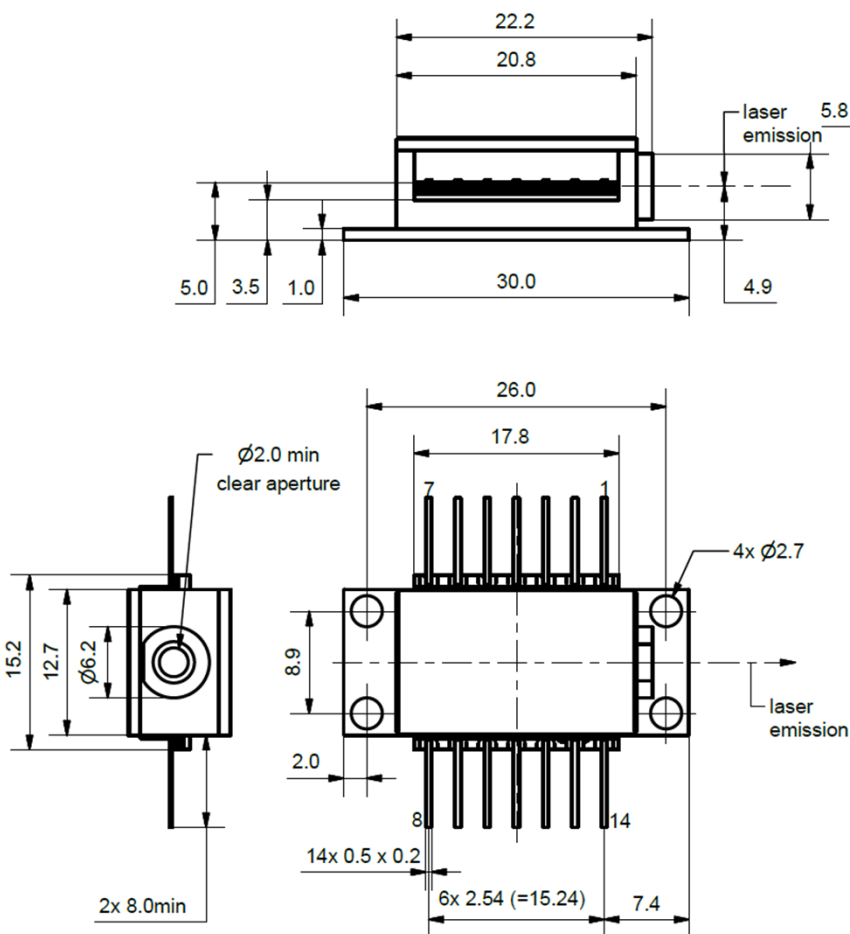

Caution. Excessive mechanical stress on the package can lead to a damage of the laser.

See [instruction manual](#) on [www.eagleyard.com](http://www.eagleyard.com)

AIZ-20-1029-0928

# EYP-DFB-0767-00050-1500-BFW01-0005

Revision 0.93

2020-11-11

## SINGLE FREQUENCY LASER DIODES Distributed Feedback Laser

### Typical Measurement Results

Output Power vs. Current

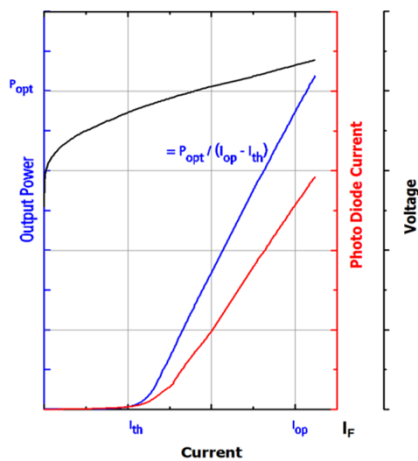

Spectra at Specified Optical Output Power

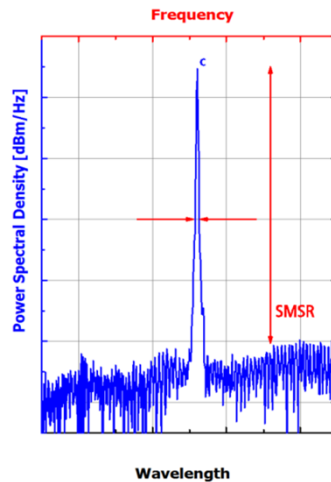

Performance figures, data and any illustrative material provided in this specification are typical and must be specifically confirmed in writing by eagleyard Photonics before they become applicable to any particular order or contract. In accordance with the eagleyard Photonics policy of continuous improvement specifications may change without notice.

### Unpacking, Installation and Laser Safety

Unpacking the laser diodes should only be done at electrostatic safe workstations (EPA). Though protection against electro static discharge (ESD) is implemented in the laser package, charges may occur at surfaces. Please store this product in its original package at a dry, clean place until final use. During device installation, ESD protection has to be maintained.

The DFB laser is sensitive against optical feedback, so an optical isolator may be required in order to avoid any disturbance of the emission spectrum. Operating at moderate temperatures on proper heat sinks will contribute to a long lifetime of the diode.

Avoid direct and/or indirect exposure to the free running beam. Collimating and focussing the free running beam with optics as common in optical instruments will increase threat to the human eye.

Performance figures, data and any illustrative material provided in this specification are typical and must be specifically confirmed in writing by eagleyard Photonics before they become applicable to any particular order or contract. In accordance with the eagleyard Photonics policy of continuous improvement specifications may change without notice.

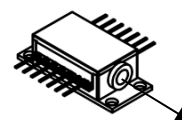

Laser Emission



IEC-60825-1



Complies with 21 CFR 1040.10 and 1040.40