

EYP-DFB-0852-00015-1500-BFY12-0005

Revision 0.90

SINGLE FREQUENCY LASER DIODES Distributed Feedback Laser



General Product Information

Product	Application
852 nm DFB Laser	Spectroscopy (Cs D2 line)
with hermetic 14-Pin Butterfly Housing (RoHS compliant)	Metrology
including Monitor Diode, Thermoelectric Cooler and Thermistor	Atomic Clock
with PM Fiber, integrated μ -Isolator and Angled Physical Contact (APC)	

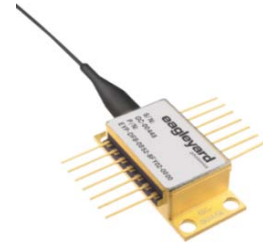

Absolute Maximum Ratings

Parameter	Symbol	Unit	min	typ	max
Storage Temperature	T_S	$^{\circ}\text{C}$	-40		85
Operational Temperature at Case	T_C	$^{\circ}\text{C}$	-15		70
Operational Temperature at Laser Chip	T_{LD}	$^{\circ}\text{C}$	10		50
Forward Current	I_F	mA			250
Reverse Voltage	V_R	V			2
Output Power	P_{opt}	mW			20
TEC Current	I_{TEC}	A			1.8
TEC Voltage	V_{TEC}	V			3.2

Measurement Conditions / Comments

Stress in excess of one of the Absolute Maximum Ratings may damage the laser. Please note that a damaging optical power level may occur although the maximum current is not reached. These are stress ratings only, and functional operation at these or any other conditions beyond those indicated under Recommended Operational Conditions is not implied.

Recommended Operational Conditions

Parameter	Symbol	Unit	min	typ	max
Operational Temperature at Case	T_{case}	$^{\circ}\text{C}$	5		60
Operational Temperature at Laser Chip	T_{LD}	$^{\circ}\text{C}$	15		45
Forward Current	I_F	mA			230
Output Power	P_{opt}	mW	5		15

Measurement Conditions / Comments

measured by integrated Thermistor

Characteristics at $T_{LD} = 25^{\circ}$ at BOL

Parameter	Symbol	Unit	min	typ	max
Center Wavelength	λ_C	nm	851	852	853
Target Wavelength	λ_T	nm		852.347	
Linewidth (FWHM)	$\Delta\lambda$	MHz		0.6	1
Mode-hop free Tuning Range	$\Delta\lambda_{tune}$	pm	25		
Sidemode Suppression Ratio	SMSR	dB	30	45	

Measurement Conditions / Comments

see images on page 4
reached within $T_{LD} = 15^{\circ} \dots 45^{\circ}\text{C}$ at 15 mW
 $P_{opt} =$
> 10 GHz, at target wavelength
 $P_{opt} = 15\text{ mW}$

EYP-DFB-0852-00015-1500-BFY12-0005

Revision 0.90



2022-10-06

SINGLE FREQUENCY LASER DIODES Distributed Feedback Laser



Characteristics at $T_{LD} = 25^\circ$ at BOL cont'd

Parameter	Symbol	Unit	min	typ	max
Temperature Coefficient of Wavelength	$d\lambda / dT$	nm / K		0.06	
Current Coefficient of Wavelength	$d\lambda / dI$	nm / mA		0.003	
Laser Current @ $P_{opt} = 15$ mW	I_{LD}	mA			230
Slope Efficiency	η	W / A		0.08	
Threshold Current	I_{th}	mA			50
Polarization Extinction Ratio	PER	dB		20	

Measurement Conditions / Comments

exfiber

$P_{opt} = 15$ mW

Monitor Diode

Parameter	Symbol	Unit	min	typ	max
Monitor Detector Responsivity	I_{mon} / P_{opt}	$\mu A/mW$	10		200

Measurement Conditions / Comments

$U_R = 5$ V

Thermoelectric Cooler

Parameter	Symbol	Unit	min	typ	max
Current	I_{TEC}	A		0.4	
Voltage	U_{TEC}	V		1.5	
Power Dissipation (total loss at case)	P_{loss}	W		0.5	
Temperature Difference	ΔT	K			55

Measurement Conditions / Comments

$P_{opt} = 15$ mW, $\Delta T = 30$ K

$P_{opt} = 15$ mW, $\Delta T = 30$ K

$P_{opt} = 15$ mW, $\Delta T = 30$ K

$P_{opt} = 15$ mW, $\Delta T = |T_{case} - T_{LD}|$

Thermistor (Standard NTC Type)

Parameter	Symbol	Unit	min	typ	max
Resistance	R	k Ω		10	
Beta Coefficient	β			3892	
Steinhart & Hart Coefficient A	A			1.1293×10^{-3}	
Steinhart & Hart Coefficient B	B			2.3410×10^{-4}	
Steinhart & Hart Coefficient C	C			8.7755×10^{-8}	

Measurement Conditions / Comments

$T_{LD} = 25^\circ$ C

$R_1 / R_2 = e^{\beta(1/T_1 - 1/T_2)}$ at $T_{LD} = 0^\circ \dots 50^\circ$ C

$1/T = A + B(\ln R) + C(\ln R)^3$

T: temperature in Kelvin

R: resistance at T in Ohm

EYP-DFB-0852-00015-1500-BFY12-0005

Revision 0.90

2022-10-06

SINGLE FREQUENCY LASER DIODES Distributed Feedback Laser



Pin Assignment

1	Thermoelectric Cooler (+)	14	Thermoelectric Cooler (-)
2	Thermistor	13	Case
3	Photodiode (Anode)	12	not connected
4	Photodiode (Cathode)	11	Laser Diode (Cathode)
5	Thermistor	10	Laser Diode (Anode)
6	not connected	9	not connected
7	not connected	8	not connected

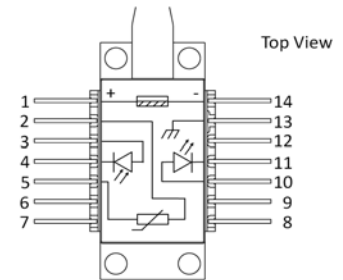

Package Drawings

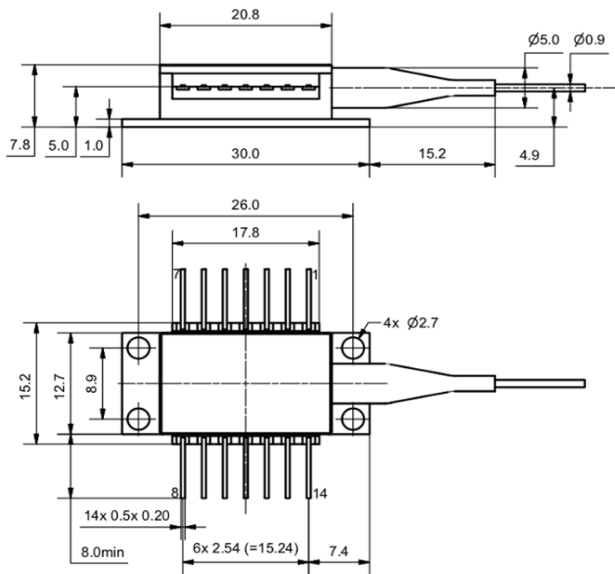

AIZ-16-0222-1415

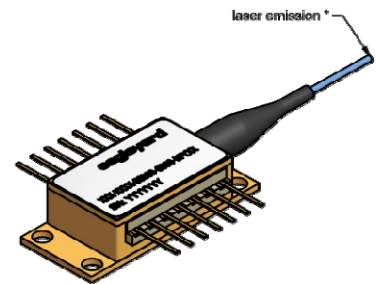

Caution. Excessive mechanical stress on the package can lead to a damage of the laser.

See [instruction manual](#) on www.eagleyard.com

Fiber and Connector Type

PM Fiber 900 / 125 / 5.5 μm, UV/Polyester-elastomer Coating (l = 1 +/-0.1 m)

Connector FC/APC (narrow key / 2mm)

Measurement Conditions / Comments

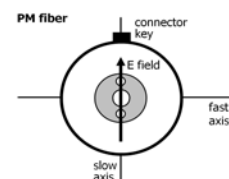

EYP-DFB-0852-00015-1500-BFY12-0005

Revision 0.90

SINGLE FREQUENCY LASER DIODES Distributed Feedback Laser



Typical Measurement Results

Output Power vs. Current

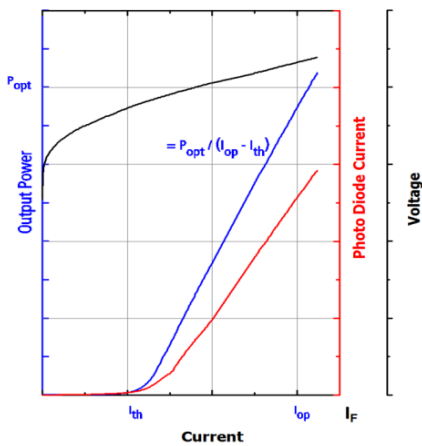

Spectra at Specified Optical Output Power

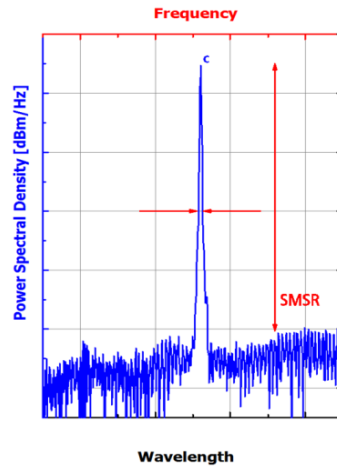

Performance figures, data and any illustrative material provided in this specification are typical and must be specifically confirmed in writing by eagleyard Photonics before they become applicable to any particular order or contract. In accordance with the eagleyard Photonics policy of continuous improvement specifications may change without notice.

Unpacking, Installation and Laser Safety

Unpacking the laser diodes should only be done at electrostatic safe workstations (EPA). Though protection against electro static discharge (ESD) is implemented in the laser package, charges may occur at surfaces. Please store this product in its original package at a dry, clean place until final use. During device installation, ESD protection has to be maintained.

The DFB laser is sensitive against optical feedback, so an optical isolator may be required in order to avoid any disturbance of the emission spectrum. Operating at moderate temperatures on proper heat sinks will contribute to a long lifetime of the diode.

Avoid direct and/or indirect exposure to the free running beam. Collimating and focussing the free running beam with optics as common in optical instruments will increase threat to the human eye.

Performance figures, data and any illustrative material provided in this specification are typical and must be specifically confirmed in writing by eagleyard Photonics before they become applicable to any particular order or contract. In accordance with the eagleyard Photonics policy of continuous improvement specifications may change without notice.

