

SINGLE FREQUENCY LASER DIODES

Distributed Bragg Reflector Laser

General Product Information

Product	Application
633 nm DBR Laser	HeNe Laser Replacement
with hermetic 14-Pin Butterfly Housing (RoHS compliant)	Spectroscopy, Metrology, Sensing
including Monitor Diode, Thermoelectric Cooler and Thermistor	Please note: The use of the laser in
Collimated beam	3D trackers is protected by patents

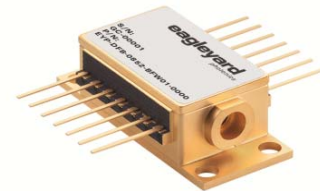

Absolute Maximum Ratings

Parameter	Symbol	Unit	min	typ	max
Storage Temperature	T_S	°C	-40		85
Operational Temperature at Case	T_C	°C	-20		75
Operational Temperature at Laser Chip	T_{LD}	°C	-5		25
Forward Current	I_F	mA			180
Reverse Voltage	V_R	V			2
Output Power	P_{opt}	mW			12
TEC Current	I_{TEC}	A			1.1
TEC Voltage	V_{TEC}	V			2.8

Measurement Conditions / Comments

Stress in excess of one of the Absolute Maximum Ratings may damage the laser. Please note that a damaging optical power level may occur although the maximum current is not reached. These are stress ratings only, and functional operation at these or any other conditions beyond those indicated under Recommended Operational Conditions is not implied.

Recommended Operational Conditions

Parameter	Symbol	Unit	min	typ	max
Operational Temperature at Case	T_{case}	°C	0		50
Operational Temperature at Laser Chip	T_{LD}	°C	10		18
Forward Current	I_F	mA		100	160
Output Power	P_{opt}	mW			10

Measurement Conditions / Comments

measured by integrated Thermistor

Characteristics at $T_{LD} = 15^\circ$ at BOL

Parameter	Symbol	Unit	min	typ	max
Center Wavelength	λ_c	nm	632	633	634
Linewidth (FWHM)	$\Delta\lambda$	MHz		1	
Sidemode Suppression Ratio	SMSR	dB	30		
Temperature Coefficient of Wavelength	$d\lambda / dT$	nm / K		0.045	
Current Coefficient of Wavelength	$d\lambda / dI$	nm / mA		0.001	

Measurement Conditions / Comments

$P_{opt} = 10$ mW

SINGLE FREQUENCY LASER DIODES

Distributed Bragg Reflector Laser

Characteristics at $T_{LD} = 15^\circ$ at BOL cont'd

Parameter	Symbol	Unit	min	typ	max
Laser Current @ $P_{opt} = 10$ mW	I_{LD}	mA			160
Slope Efficiency	η	W / A	0.1	0.4	0.7
Threshold Current	I_{th}	mA		80	120
Divergence parallel (FWHM)	$\Theta_{ }$	°		0.1	
Divergence perpendicular (FWHM)	Θ_{\perp}	°		0.1	
Beam Diameter horizontal ($1/e^2$)	$d_{ }$	mm		0.7	1.0
Beam Diameter vertical ($1/e^2$)	d_{\perp}	mm		0.6	1.0
Degree of Polarization	DOP	%		90	

Measurement Conditions / Comments

lth drift may occur, no violation of the max. value
parallel to the base plate of the housing (see p. 3)
perpendicular to base plate of the housing (see p. 3)
parallel to the base plate of the housing (see p. 3)
perpendicular to base plate of the housing (see p. 3)
 $P_{opt} = 10$ mW; E field perpendicular to base plate

Monitor Diode

Parameter	Symbol	Unit	min	typ	max
Monitor Detector Responsivity	I_{mon} / P_{opt}	μ A/mW	10		400

Measurement Conditions / Comments

$U_R = 5$ V

Thermoelectric Cooler

Parameter	Symbol	Unit	min	typ	max
Current	I_{TEC}	A		0.7	1.1
Voltage	U_{TEC}	V		1.7	2.8
Power Dissipation (total loss at case)	P_{loss}	W		0.4	0.5
Temperature Difference	ΔT	K			60

Measurement Conditions / Comments

$P_{opt} = 10$ mW, $\Delta T = 40$ K

$P_{opt} = 10$ mW, $\Delta T = 40$ K

$P_{opt} = 10$ mW, $\Delta T = 40$ K

$P_{opt} = 10$ mW, $\Delta T = |T_{case} - T_{LD}|$

Thermistor (Standard NTC Type)

Parameter	Symbol	Unit	min	typ	max
Resistance	R	k Ω		10	
Beta Coefficient	β			3892	
Steinhart & Hart Coefficient A	A			1.1293×10^{-3}	
Steinhart & Hart Coefficient B	B			2.3410×10^{-4}	
Steinhart & Hart Coefficient C	C			8.7755×10^{-8}	

Measurement Conditions / Comments

$T_{LD} = 25^\circ$ C

$R_1 / R_2 = e^{\beta(1/T_1 - 1/T_2)}$ at $T_{LD} = 0^\circ \dots 50^\circ$ C

$1/T = A + B(\ln R) + C(\ln R)^3$

T: temperature in Kelvin

R: resistance at T in Ohm

EYP-DBR-0633-00010-2000-BFW01-0000

Revision 0.74

2017-07-05

SINGLE FREQUENCY LASER DIODES Distributed Bragg Reflector Laser

Pin Assignment

1	Thermoelectric Cooler (+)	14	Thermoelectric Cooler (-)
2	Thermistor	13	Case
3	Photodiode (Anode)	12	not connected
4	Photodiode (Cathode)	11	Laser Diode (Cathode)
5	Thermistor	10	Laser Diode (Anode)
6	not connected	9	not connected
7	not connected	8	not connected

All 14 pins are isolated from case.

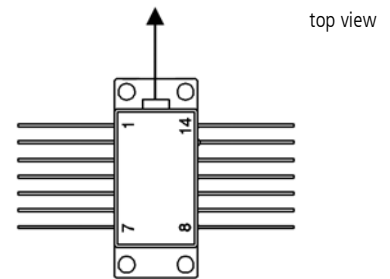

Package Drawings

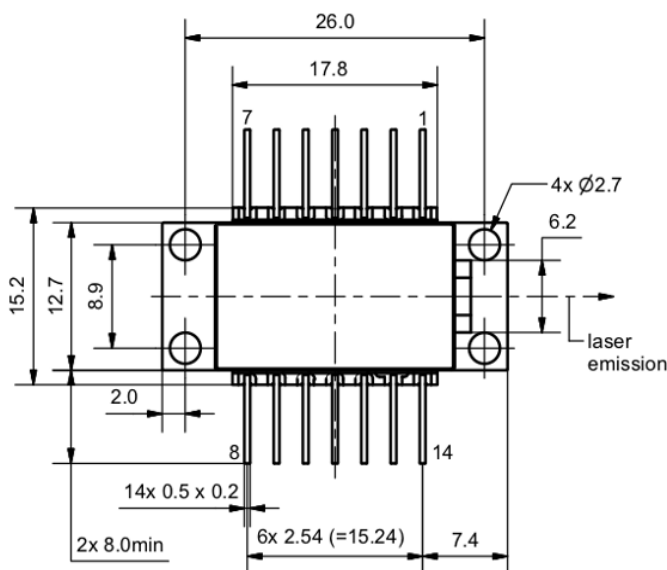
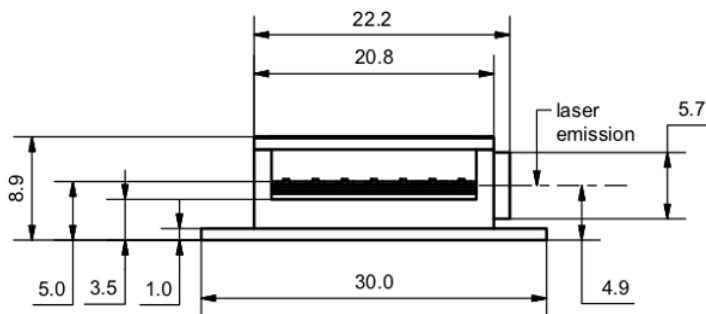

AIZ-15-0729-0947

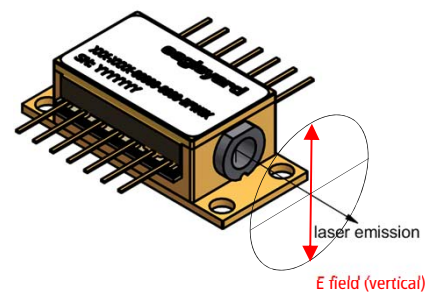

EYP-DBR-0633-00010-2000-BFW01-0000

Revision 0.74

2017-07-05

SINGLE FREQUENCY LASER DIODES Distributed Bragg Reflector Laser

Typical Measurement Results

Output Power vs. Current

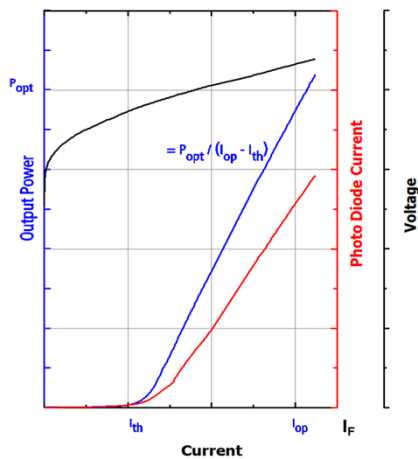

Spectra at Specified Optical Output Power

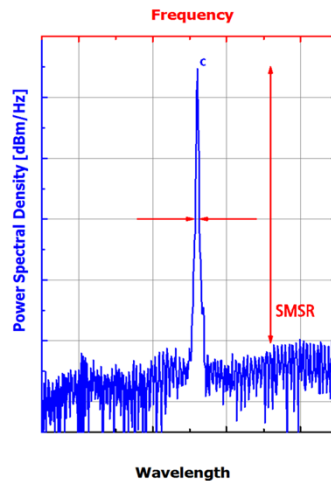

Performance figures, data and any illustrative material provided in this specification are typical and must be specifically confirmed in writing by eagleyard Photonics before they become applicable to any particular order or contract. In accordance with the eagleyard Photonics policy of continuous improvement specifications may change without notice.

Unpacking, Installation and Laser Safety

Unpacking the laser diodes should only be done at electrostatic safe workstations (EPA). Though protection against electro static discharge (ESD) is implemented in the laser package, charges may occur at surfaces. Please store this product in its original package at a dry, clean place until final use. During device installation, ESD protection has to be maintained.

The DBR laser is sensitive against optical feedback, so an optical isolator may be required in order to avoid any disturbance of the emission spectrum. Operating at moderate temperatures on proper heat sinks will contribute to a long lifetime of the diode.

Avoid direct and/or indirect exposure to the free running beam. Collimating and focussing the free running beam with optics as common in optical instruments will increase threat to the human eye.

Performance figures, data and any illustrative material provided in this specification are typical and must be specifically confirmed in writing by eagleyard Photonics before they become applicable to any particular order or contract. In accordance with the eagleyard Photonics policy of continuous improvement specifications may change without notice.

